



Contents lists available at ScienceDirect

Applied Geochemistry

journal homepage: www.elsevier.com/locate/apgeochem

Use of lithium tracers to quantify drilling fluid contamination for groundwater monitoring in Southeast Asia



Laura A. Richards^{*}, Daniel Magnone, Bart E. van Dongen, Christopher J. Ballentine¹, David A. Polya

School of Earth, Atmospheric and Environmental Sciences and Williamson Research Centre for Molecular Environmental Science, The University of Manchester, Williamson Building, Oxford Road, Manchester M13 9PL, United Kingdom

ARTICLE INFO

Article history:

Received 16 April 2015

Received in revised form

17 August 2015

Accepted 20 August 2015

Available online 24 August 2015

Keywords:

Chemical tracers

Lithium

Drilling fluid

Groundwater

Monitoring well contamination

ABSTRACT

Drilling is widely used in groundwater monitoring and many other applications but has the inherent problem of introducing some degree of external contamination into the natural systems being monitored. Contamination from drilling fluid is particularly problematic for (i) wells with relatively low water flow rates which are difficult to flush; and for (ii) hydrogeochemical research studies of groundwaters hosted by incompletely consolidated shallow sediments, which are widely utilized as sources of drinking water and irrigation water across many parts of Asia. Here, we develop and evaluate a method that can be simply used to quantify the extent of drilling fluid contribution to a water sample either to optimize sample collection for reduced contamination, or to allow a correction for contamination to be made. We report the utility of lithium chloride tracers using both field and laboratory analytical techniques to quantitatively evaluate and correct for drilling fluid contamination of casing waters through an investigation of 15 sites in Kandal Province, Cambodia. High analytical errors limit the practicality and resolution of field-based lithium ion selective electrode measurements for purposes other than broad estimates of gross contamination. However, when laboratory analysis is integrated with the method (e.g. via inductively coupled plasma atomic emission spectrometry analysis), lithium tracers can provide a robust and accurate method for evaluating drilling-related contamination if appropriate samples are collected. Casing water is susceptible to contamination from drilling fluid which was shown to be significantly reduced within two to three well volumes of flushing but can still persist above background for greater than seven well volumes of flushing. A waiting period after drilling and prior to water sampling was shown to further decrease contamination due to dilution from the surrounding aquifer, particularly in more permeable wells. Contamination values were generally <3% for 34 monitoring wells across 15 sites after flushing a mean of 4.6 ± 3.8 well volumes, even when lithium-spiked water was directly injected during flushing to remove settled mud/debris. Operational issues can be encountered which can (i) lead to contamination being much higher than the mean if wells are highly unproductive and clay-dominated or (ii) lead to higher flushing volumes than the mean particularly in sandy areas where fine sand may enter the well screening. General correction factors have been provided for typical monitoring wells in poorly consolidated shallow aquifers in Southeast Asia, and examples provided for how to correct other groundwater data for contamination. For most analytes such as sodium or dissolved organic carbon (DOC), specific corrections may not be necessary for the typical magnitude of contamination encountered, particularly when the differences in concentrations between the drilling fluid and groundwater are relatively small. In the particular circumstance where drilling fluid may have much higher DOC than groundwaters, or vice versa with drilling fluid having much lower DOC than groundwaters in organic-rich alluvial sediments, corrections may still be necessary and significant. Similarly, for highly sensitive parameters such as ^{14}C model age or other age-related parameters (such as tritium, chlorofluorocarbons (CFCs) or sulfur hexafluoride (SF_6)), corrections can be significant in typical field scenarios particularly when contamination values are high and/or there is a large difference in age between groundwater and drilling fluid. The lithium method was verified with comparison to changes in concentration of a suite of representative and naturally occurring groundwater constituents as a function

^{*} Corresponding author.

E-mail address: laura.richards@manchester.ac.uk (L.A. Richards).

¹ Present address: Department of Earth Sciences, University of Oxford, South Parks Road, Oxford OX1 3AN, United Kingdom.

of well flushing from relatively low and high permeability groundwater monitoring wells to further illustrate the technique.

© 2015 The Authors. Published by Elsevier Ltd. This is an open access article under the CC BY license (<http://creativecommons.org/licenses/by/4.0/>).

1. Introduction

Drilling procedures have the inherent and unavoidable problem of introducing some degree of external contamination into natural groundwater systems. The quantification of contamination resulting from drilling procedures may therefore be essential information required for the scientific interpretation of chemical data from groundwaters obtained from drilled monitoring wells. Chemical tracers can be used to track the distribution of drilling fluid during well drilling (Bath, 2011) and which directly allow for monitoring and quantification of drilling-related contamination in groundwaters.

Drilling tracers have important applications in a number of fields including groundwater investigations (Bottrell et al., 2010; Edmunds and Bath, 1976; Riley et al., 2001; Smart and Laidlaw, 1977), oil and gas exploration (Kleven et al., 1996; Warner et al., 2014), geothermal energy surveys (Adams et al., 1992; Chrysikopoulos and Kruger, 1987) and other geoscientific (McKinley and Colwell, 1996; Smith et al., 2000) and microbiological (Kallmeyer et al., 2006) studies. This is also essential in the context of research into the biogeochemistry of arsenic in shallow reducing aquifers (Charlet and Polya, 2006; Lloyd and Oremland, 2006; Polya and Charlet, 2009), where the quantification of possible introduction of surface water into sediments and groundwaters is particularly important due to the often incompletely consolidated sediments encountered during drilling and the potentially serious implications of drilling contamination on interpretation of inorganic water chemistry, organic water composition and model groundwater dates (Aggarwal et al., 2003; Darling et al., 2012; Goody et al., 2006; Harvey et al., 2003, 2002; Lawson et al., 2013; McArthur et al., 2011; Neumann et al., 2010; Rowland et al., 2007; Sengupta et al., 2008; van Geen et al., 2004; van Geen et al., 2008; van Geen et al., 2003).

Various tracers have been used during drilling procedures in the pursuit of different aims (Bath, 2011). The selection criteria for drilling tracers includes background levels; chemical stability in the relevant environment; the degree of conservative and non-sorbing behavior; ease and technical capability of in-field monitoring; analytical detection limits; cost of materials; and minimization of adverse effects on the environment, health (human and/or animal) and/or public perception and acceptability. Tracer selection is thus application-dependent and reflects a balance of considerations. Most tracers fall into two categories: (i) dye compounds and (ii) inorganic compounds (Bath, 2011) and the relative merits of these are discussed briefly below.

Dyes (fluorescent or non-fluorescent) are typically polycyclic aromatic carboxylic organic compounds such as rhodamine WT, rhodamine D, fluorescein, uranine, amino-G acid, fluorobenzoic acid and blue dye (Di Fazio and Vurro, 1994; Penteleit et al., 2006; Sabiani and Austin, 1991; Wandrey et al., 2010). Dyes are very commonly used and have the advantage of easy and rapid on-site analysis. However, organic dyes are much more chemically complex than water, have complex sensitivities to light, pH, salinity, temperature and water composition, and exhibit significant sorption, especially to clays that may be encountered during drilling procedures. These disadvantages severely diminish their value for drilling applications.

Alternatively, inorganic tracers, such as lithium, iodide, bromide, potassium, chloride, nitrate and thiocyanate, exhibit the advantages of simple hydrochemical behavior, simple composition, general insensitivity to environmental conditions such as pH, and improved persistence in drilling fluid as compared to organic dyes. However, inorganic tracers are often avoided in field studies as they generally require more complicated and off-site chemical analysis which may be impractical in the field context. Another potential disadvantage of cationic tracers, in particular, is that ion exchange reactions can occur between a cationic tracer and charged functional groups on the surface of clay materials if unbalanced electrical charges are present. Because these ion exchange reactions are reversible and highly dependent on the nature of the mineral framework within the sediments, they can be variable and difficult to quantify in a natural environment (Bath, 2011; Carroll, 1959; Gast and Klobe, 1971). It is well established that the affinity of various types of clays for cations decreases with increasing hydrated radii, with the order of preference being $\text{Cs}^+ > \text{Rb}^+ > \text{K}^+ > \text{Na}^+ > \text{Li}^+$ (Carroll, 1959; Gast and Klobe, 1971).

Thus, of the possible cationic tracers, lithium exhibits the lowest ion-exchange capacity with clay materials (Carroll, 1959; Gast and Klobe, 1971), indicating its comparative potential as an excellent tracer. Furthermore, background levels of lithium are generally low (for example ranging from <1.0 to 34 $\mu\text{g/L}$ in UK aquifers) (Kinniburgh and Smedley, 2001; Shand et al., 2007) ensuring that the majority of lithium observed is typically derived from tracer spiking. Indeed, lithium has previously been used as a drilling tracer for various applications such as site characterisation (McCartney and de L.G. Solb e, 1999), tracing in porous aquifers (Ptak et al., 2004; Vereecken et al., 2000), hydraulic tracing in wetlands (Dierberg and DeBusk, 2005), the evaluation of fluid-sediment reactions in volcanoes using isotopes (Chan and Kastner, 2000), fracking (Warner et al., 2014), and evaluating interstitial waters of marine sediments in ocean drilling (You et al., 1995; Zhang et al., 1998). Notwithstanding this, lithium is often avoided partly due to difficulties in in-field detection and, in particular, to our knowledge, lithium has not been used as a tracer to specifically evaluate the drilling-induced contamination of groundwater collected from shallow monitoring wells (<45 m in depth) drilled in poorly consolidated sediments.

Such poorly consolidated sediments hosting heavily exploited aquifers are widespread in many parts of the world but particularly in densely populated lowland river basins of circum-Himalayan Asia (Charlet and Polya, 2006). The use of these aquifers as a source of drinking water has led to massive detrimental health outcomes to those exposed to arsenic contained in the waters (Charlet and Polya, 2006; Polya and Charlet, 2009). Although this arsenic is largely held to be of geogenic origin, there is an ongoing debate about the importance of irrigation-enhanced ingress of surface-derived waters (Aggarwal et al., 2003; Harvey et al., 2002; Polya and Charlet, 2009) and detailed hydrogeochemical studies are critical to resolving this. Kandal Province, Cambodia is one of several areas in southern and south-east Asia broadly typical of such arsenic-impacted aquifers (Charlet and Polya, 2006) and is the focus of significant research studies of arsenic biogeochemistry (Buschmann and Berg, 2009; Charlet and Polya, 2006; Lawson et al., 2013; Polizzotto et al., 2008; Polya et al., 2008; Polya and Charlet,

2009; Rowland et al., 2007; Sovann and Polya, 2014); this, together with logistical reasons, provided an ideal area in which to test the utility of lithium tracers in shallow aquifers hosted by poorly consolidated sediments.

The aim of this work is to evaluate the magnitude of contamination of groundwaters resulting from some manual drilling techniques in shallow soft sedimentary aquifers in Southeast Asia using lithium tracers. This will allow the determination of site and sample-specific correction factors for subsequent chemical analysis of samples collected from these monitoring wells as well as providing an improved understanding of potential contamination arising from these drilling techniques. The primary objectives of this study were to (i) determine the effectiveness of lithium tracers to quantify drilling fluid contamination in shallow soft sedimentary aquifers; (ii) determine the rates of diminution of drilling-induced contamination in casing water during well development; and (iii) consider appropriate mitigation or correctional strategies for the contamination of wells used for scientific monitoring of aquifer waters.

2. Methods and materials

2.1. Drilling methods

This study focuses on 34 monitoring wells drilled into poorly consolidated shallow sediments across 15 sites in a 50 km² area in Kandal Province, Cambodia, located approximately 12 km south-east of Phnom Penh. Study sites were coded for identification as LRXX-YY where XX represents a specific site number and YY is the well depth in meters. All sites had clusters of at least two wells of different depths (typically 15 and 30 m) within several meters of each other, and lithology varied at the different sites. Details of the sedimentary characteristics (e.g. mineralogy, organic content and composition, ¹⁴C age, geological context, hydraulic conductivity, etc.) typical to this field area are published elsewhere (Benner et al., 2008; Rowland et al., 2008; Tamura et al., 2007; van Dongen et al., 2008).

The local drilling technique used was manual rotary drilling, which is a method widely used both in Cambodia and other countries in south-east and southern Asia. The specific drilling procedure followed was based on local drilling practices and the knowledge and experience of the local drilling team; some regional variations in working practices may be expected. A steel pipe (7.6 cm diameter, in 3 m segments) was attached to a cutting auger (10.2 cm) and manually rotated until the desired well depth was reached.

Drilling fluid was continuously pumped using a suction pump (Honda WB30XT, Cambodia) through the steel pipe to remove drilling cuttings and allow for manual rotation of the drilling equipment. Locally available water (either surface or groundwater) in relatively close proximity to the drilling site was used as the drilling fluid. As drilling progressed, drilling fluid was recycled to the drilling fluid reservoir and refilled periodically when required. The mean quantity of net drilling fluid used was approximately 70 L m⁻¹ of drilling depth (equivalent to ~ 2 m³ per 30 m well). Fig. 1 shows a schematic of the various fluid reservoirs and the transfers taking place during the drilling process. When the desired depth was achieved, the drilling fluid was circulated in the borehole for approximately five to 10 min to initially displace settled debris from the borehole prior to casing. Wells were then cased with PVC (6.97 cm inner diameter, manufactured in Kandal Province, Cambodia) with one meter of capped screening at the bottom of the casing. The dead volume between the bottom of the screen and the base of the capped casing was approximately 0.2 L. The outside of the casing was backfilled first with weathered, locally available

quartzite alluvial gravel as the gravel pack, then finished by backfilling with the original sediments and sealed with clay and concrete at the surface. The PVC casing protruded approximately 50 cm above the ground surface. All wells were capped and locked when not in use.

Wells were developed in the first instance by pumping compressed air (Yokohama GX-200, Japan) to the base of the casing via a flexible plastic tube (approximately either 15 mm or 25 mm diameter), which caused settled debris and water to be displaced from the well and allowed for sample collection as a function of flushing volume. When the airlift pumping method was used, the tube was manually moved vertically within the casing to maximize water and debris displacement. Where pumping compressed air did not provide sufficient force for well development (e.g. in relatively low productivity wells), a submersible pump (Grundfos MP1, UK) or peristaltic pump (Geotech Easy Load II, UK) for shallow wells (6 and 9 m) was alternatively used. In order to protect the sensitive down-hole components of the MP1, this pump was placed at a depth of approximately 50–70% down the well. The intake end of the tubing for the peristaltic pump was placed near the bottom of the shallow wells. The airlift pump air was the preferred pumping method for well development when possible, as neither the MP1 nor peristaltic pump are suitable for moving high loading of sediment/mud. The volume of development water was measured by collecting the displaced water and measuring the volume. The final casing water sampling was done using the MP1 and peristaltic pump, as depth appropriate, at the same pump positions used for well development. The dead volume related to the intake of the pump was approximately 14 L for the MP1 and 0.2 L for the peristaltic pump, which is related to the pump tubing length and diameter. The dead volume was discarded prior to sampling or taking other measurements to ensure that the casing water was being pumped.

In this manuscript, the term “flushing” refers to the well development process of pumping casing water from the well, using one of the three pumping methods described in the previous paragraph. Where pumping occurred as already described, this is the method noted as “Regular Flushing” in this manuscript. However, in some cases, where a substantial amount of debris/mud had settled or collected during drilling, a different well development technique was required. In this case, direct injection of drilling fluid into the casing (using the primary drilling suction pump Honda WB30XT) was required to displace the debris/mud via circulation and throughflow. This direct injection was immediately followed by pumping casing water from the aquifer, allowing new casing water to enter the well as above. This alternate method of development is noted as “Direct Injection” and was only used in wells with a substantial amount of settled debris.

In this manuscript, the term “well volume” refers to the volume of the water column within the well casing. The normalized number of well volumes (unitless) corresponds to an absolute water volume (L), which varies with each well according to the well depth as well as the water level within the well (United States Environmental Protection Agency Environmental Response Team, 2001). Because the depth and water level are well-specific, the number of well volumes has been used in reference to flushing rather than absolute water volume. For example, one well volume corresponds to a water volume of approximately 107 L for a 30 m well with a water level of 2 m; or 50 L for a 15 m well with the same water level (given a casing inner diameter of 6.97 cm). Two well volumes would correspond to twice the above water volumes, and so on. Water level was measured with a dip meter (Solinst Water Level Dip Tape Model 101 P2/M3/30 m), and typically ranged from 2 to 5 m below ground surface.

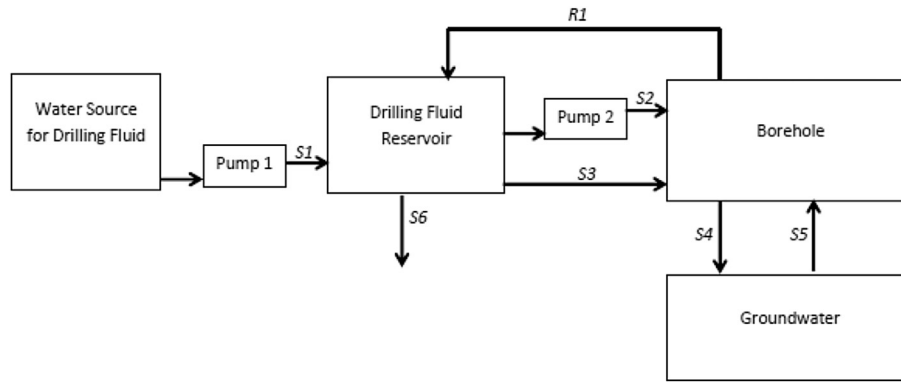

Fig. 1. Flow schematic of fluid reservoirs and transfers involved in the manual drilling process with local techniques. S_1 represents the water source stream into the drilling fluid reservoir; S_2 is the pressurized stream to assist with drilling; S_3 is direct leakages from the drilling fluid reservoir into the borehole; S_4 are losses of drilling fluid into the surrounding groundwater at depth; S_5 is ingress of surrounding groundwater into the borehole; S_6 are surface losses due to overflows, evaporation, etc.; and R_1 is the recycle of drilling fluid back into the drilling fluid reservoir.

2.2. Tracer methods

Lithium chloride (lithium chloride anhydrous, laboratory reagent grade, Fisher Scientific UK) was selected as the target tracer and spiked into the drilling fluid reservoir or injection fluid reservoir as a concentrated solution of lithium chloride in deionized water and well-mixed into the reservoir by manual stirring. The targeted mean overall concentration in the drilling fluid was approximately 50 mg L^{-1} as lithium. The concentration was selected to be (i) sufficiently high to permit changes to be monitored; (ii) substantially higher than expected background groundwater concentration; (iii) low enough as to avoid significant potential changes to groundwater chemistry, environment, aesthetic and/or health parameters of water (for example, in unlikely case of the unintended consumption of substantially drilling fluid contaminated borehole waters by animals or people); and (iv) cost. In order to maintain the concentration in the drilling fluid, as drilling fluid was used and diluted, lithium was periodically topped up as required (typically three times during the drilling of a 30 m borehole).

Lithium concentrations in grab samples of the drilling fluid were measured (i) initially; (ii) after every 3 m of drilling; and (iii) before

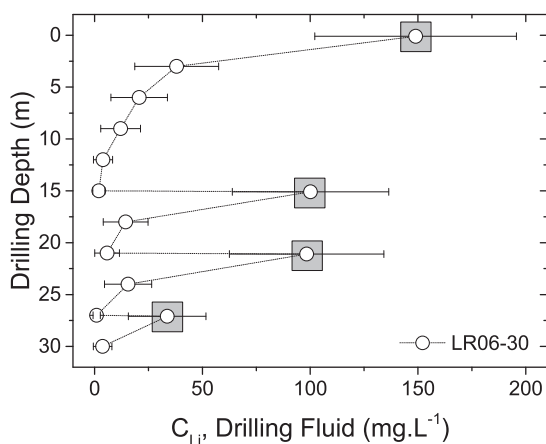

Fig. 2. Concentration of lithium chloride (C_{Li} , mg L^{-1}) tracer based on ion selective electrode measurements in drilling fluid shown against drilling depth for well LR06-30. Lithium chloride was manually added to the drilling fluid prior to commencing drilling and subsequently whenever measured lithium concentrations fell below the targeted mean concentration of approximately 50 mg L^{-1} . Grey boxes show points of manual lithium chloride addition.

and after every new addition of lithium to the reservoir (Fig. 2). In the drilling fluid, lithium concentrations accordingly spike due to initial and periodic addition of lithium to drilling fluid reservoir, and decrease due to drilling fluid being used, dilution of drilling fluid from regular refilling of reservoir and surface losses. When direct injection of water was required during flushing to displace settled mud/debris (e.g. in very low permeability monitoring wells), lithium was mixed into the injection water in a 500 L rainwater tank used as the injection water reservoir in which the targeted lithium feed concentration was also approximately 50 mg L^{-1} . Field measurements of lithium concentrations of casing water samples were measured at the time of water flushing, which generally occurred within several weeks after the completion of drilling. All field lithium measurements were made as soon as possible after sample collection (generally within 20 min of sample collection).

2.3. Chemical analysis and error estimation

Lithium concentrations in the field were measured using a lithium ion selective electrode (ISE; custom-made single ion probe, CleanGrow, Ireland). Direct field measurements were made as an electrical signal (S_{Li} , mV) and converted into concentration values (C_{Li} , mg L^{-1}) by using a logit calibration curve (of generic form $\text{logit } x = \ln[x/(1-x)]$) (Miller and Miller, 2010). The logit calibration curve plots $\text{log}(\omega + C_{Li})$ against S_{Li} where $\omega = 0.35$ for standards of known concentration. A modelled weighted ordinary least squares linear regression (Miller and Miller, 2010) of the calibration gives a slope $\text{log}(\omega + C_{Li}, \text{mg L}^{-1}) \text{ mV}^{-1}$ and intercept, allowing the conversion of measured S_{Li} (mV) to C_{Li} (mg L^{-1}). A full calibration of the ISE was conducted during equipment commissioning with lithium concentrations, C_{Li} , of 0, 0.01, 0.08, 0.25, 1.0, 5.0, 10, 100, 500 and 1000 mg L^{-1} . Calibrations of three standards ($C_{Li,Std} = 10, 100$ and 1000 mg L^{-1}) were checked daily in the field to monitor and correct for changes in sensitivity arising from sensor status, temperature and other field conditions. The supplier-provided detection limit was 0.1 mg L^{-1} .

Calibration parameters shifted in systematic segments during the duration of multiple sampling periods (Fig. 3). The observed shifts in the three-point field calibrations were: (i) a general increase in signal over 175 days for a 10 mg L^{-1} standard solution, followed by a marked decrease in signal after 175 days of field usage; and (ii) a general increase in the slope of the calibration curve. Because of the shifts in calibration parameters over the sampling campaigns, three distinct calibrations have been used for each of the “Blocks” indicated on Fig. 3 using calibration parameters

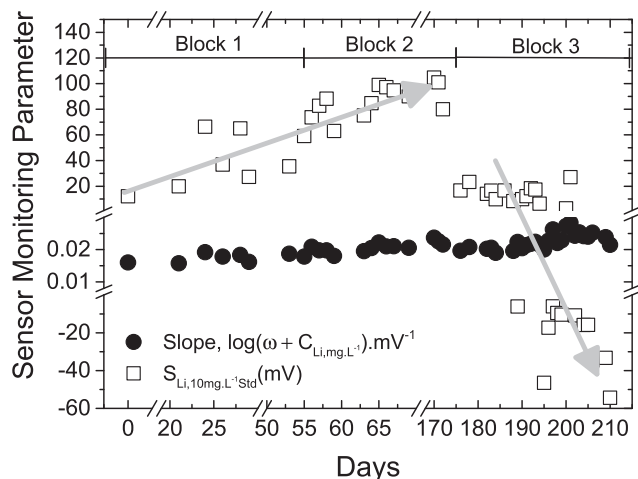

Fig. 3. Electrical signal, $S_{Li,10mg/LStd}$ (mV) of a 10 mg L^{-1} lithium calibration standard and slope $\log(\omega + C_{Li,mg L^{-1}}) \text{ mV}^{-1}$ of the three-point field calibration (10, 100, 1000 mg L^{-1}) as measured by the lithium ion selective electrode versus days of probe usage in the field. Day 0 represents equipment commissioning done in the laboratory; all other measurements are done in field conditions. Blocks indicate segments of where distinct calibrations were used for representative days within the block. Block 1 is from Day 0 – Day 54 (19 Nov 2013 – 12 Jan 2014) and represented by Day 28 (17 Dec 2013); Block 2 is from Day 55 – Day 175 (13 Jan 2014 – 13 May 2014) and represented by Day 59 (17 Jan 2013); and Block 3 is from Day 176 – Day 210 (14 May 2014 – 17 June 2014) and represented by Day 195 (02 June 2014). Grey arrows indicate the direction of changes for $S_{Li,10mg/LStd}$. The decrease in signal during Block 3 is attributed to the low concentrations of lithium presented to the electrode during this time (see text for further detail).

for a representative day within that block. It is expected that the decrease in sensor signal in Block 3 of the sampling campaign is attributed to the low concentrations of lithium presented to the electrode during this time and hence longer time required for the signal to stabilize. Longer soaking times are not ideally recommended for sensor use as this could result in diffusion of the reference solution from the reference electrode and hence reduction in electrode signal.

Particularly because of the shifts in calibration parameters across the field campaign as shown on Fig. 3, a reasonably robust estimation of the errors associated with lithium ISE measurements is required. Errors for the calculated C_{Li} (mg L^{-1}) values were approximated based on a modelled weighted ordinary least squares regression of representative calibration data for each block according to the date of measurement (Fig. 4). Errors were based on the value of the measured signal relative to the signal of the 10 mg L^{-1} standard. This error analysis shows the error of a particular measurement is highest for the latest part of the sampling campaigns (e.g. Block 3) and for samples with the greatest difference between measured S_{Li} (mV) and $S_{Li,10mg L^{-1}Std}$ (e.g. very low concentrations).

The lithium tracer field method was validated by the analysis of a suite of representative groundwater constituents (sodium, ammonium, calcium, alkalinity, chloride, nitrate, arsenic, iron and lithium). Cationic components were measured in the laboratory of the Manchester Analytical Geochemistry Unit (MAGU) at The University of Manchester on samples filtered (0.45 μm cellulose and polypropylene syringe filters, Minisart RC, UK) and acidified to $\text{pH} < 2$ (trace grade nitric acid, BDH Aristar, UK) using inductively coupled plasma atomic emission spectrometry (ICP-AES, Perkin-Elmer Optima 5300 dual view) for sodium, calcium, iron and lithium, and using inductively coupled plasma mass spectrometry (ICP-MS, Agilent 7500cx) for arsenic. Chloride was measured using ion chromatography (IC, Dionex ICS5000 Dual Channel Ion Chromatograph) on 0.45 μm filtered, non-acidified samples. Ammonium

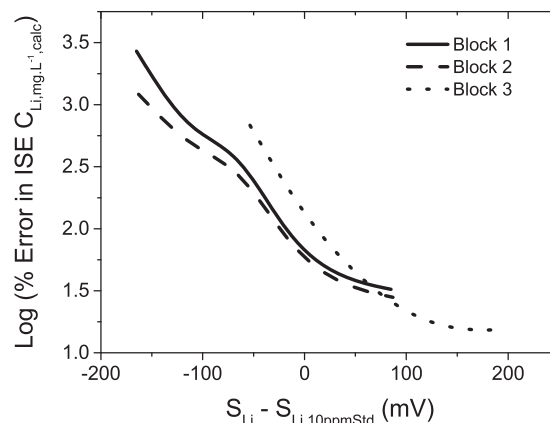

Fig. 4. Error approximations for ISE field measurements based on a modelled weighted ordinary least squares regression of calibration data (Miller and Miller, 2010). Errors for ISE field measurements were based on the difference between any measured S_{Li} (mV) relative to the $S_{Li,10ppmStd}$ (mV) of the as measured on the representative day of the appropriate block (e.g. 17 Dec 2013 for Block 1; 17 Jan 2014 for Block 2; and 02 June 2014 for Block 3) according to the day of measurement (as shown on Fig. 3). The error for a given C_{Li} (mg L^{-1}) was estimated based on a linear fit of the modelled lines shown here.

and nitrate were measured *in-situ* using a field spectrophotometer (Spectroquant Nova 60A, Merck, Germany) and appropriate test kits (ammonium cell test 114,739 for $0.01\text{--}2.00 \text{ mg L}^{-1}$; ammonium cell test 114,559 for $4.0\text{--}80.9 \text{ mg L}^{-1}$; nitrate reagent test 109,713 for $0.10\text{--}25.0 \text{ mg L}^{-1}$, all Merck, Germany). Alkalinity (as acid neutralizing capacity (ANC)) was measured *in-situ* on unfiltered samples using a field visual titration kit (Aquamerck 111109, Merck, Germany) and confirmed with Gran Titration generally within 24 h. Analytical errors in these measurements are obviously concentration-dependent but for calibration measurements were around 3% for chloride and arsenic; 5% for lithium and sodium; 6% for iron and calcium; and 10% for ammonium, alkalinity and nitrate. This geochemical analysis was required to meet the objectives of this specific study for the purposes of method development, quality control and validation, but the same level of geochemical detail may not be necessary for applications where only gross estimations of contamination are required.

The mean baseline lithium concentration of groundwater samples collected from *unspiked* wells was 0.01 mg L^{-1} ($N = 15$ sites), as measured by ICP-AES (as this is below the detection of the ISE). Baseline values for these groundwaters are roughly consistent with other groundwaters in Bangladesh and elsewhere, where typical groundwater lithium concentrations are $< 0.1 \text{ mg L}^{-1}$ (Kinniburgh and Smedley, 2001; Shand et al., 2007). Samples of the contaminated drilling fluid were not collected for ICP-AES, ICP-MS or IC analysis.

2.4. Calculation of correction factors

The degree of drilling fluid contamination can be quantified in order to verify the lithium tracer method, to optimize sample collection for reduced contamination, or to allow a correction for contamination to be made. The model volume fraction of the drilling fluid end-member in the mixed contaminated sample, $X_i[D]$, is

$$X_i[D] = \frac{C_i - C_i[G]}{C_i[D] - C_i[G]}, \quad (1)$$

where C_i is the concentration of any analyte, $C_i[D]$ is the concentration in the drilling fluid end-member (e.g. C_i when $X_i[D] = 1$) and

$C_i[G]$ is the groundwater end-member (e.g. C_i when $X_i[D] = 0$). Equation (1) is valid given the assumptions of (i) conservative mixing of lithium; (ii) equal density of drilling fluid and groundwater; (iii) no density change upon mixing; and (iv) constant concentration of $C_i[G]$. For the specific case where $C_i[G]$ is very low, as is the case with spiked lithium, a range of $X_i[D]$ values can be calculated for various degrees of well flushing by:

$$X_{Li}[D] \approx \frac{C_{Li}}{C_{Li}[D]} \quad (2)$$

In this manuscript we have referred to $X_{Li}[D]$ as a “two-point” parameter because two inputs are needed (e.g. C_{Li} and $C_{Li}[D]$). Where $X_{Li}[D]$ is notated as $X_{Li}[D](ICP-AES)$, C_{Li} is from ICP-AES analysis; conversely where $X_{Li}[D]$ is notated as $X_{Li}[D](ISE)$, C_{Li} is from ISE analysis. Both notations of $X_{Li}[D]$ use ISE measurements averaged over the drilling depth for $C_{Li}[D]$ (see Fig. 2), as drilling fluid was not sampled for ICP-AES analysis.

If $X_{Li}[D] > 0$, the concentration, $C_{i,meas}$, of any analyte, i , is therefore a simple mixture of concentrations of that analyte in the drilling fluid and in the groundwater, and given by:

$$C_{i,meas} = X_{Li}[D] \cdot C_i[D] + ((1 - X_{Li}[D]) \cdot C_i[G]) \quad (3)$$

$C_{i,meas}$ can be corrected for drilling fluid contamination, as long as $X_{Li}[D]$ and $C_i[D]$ are known, to obtain a corrected concentration, $C_{i,corr}$, by rearrangement of Equation (3):

$$C_{i,corr} \approx C_i[G] \approx \frac{C_{i,meas} - (X_{Li}[D] \cdot C_i[D])}{1 - X_{Li}[D]} \quad (4)$$

A predicted concentration, $C_{i,pred}$, for different constituents in the groundwater can be made if $X_{Li}[D]$ (requiring both C_{Li} and $C_{Li}[D]$), $C_i[D]$, and $C_i[G]$ are known or estimated, as given by

$$C_{i,pred} = X_{Li}[D] \cdot (C_i[D] - C_i[G]) + C_i[G] \quad (5)$$

$C_{i,pred}$ can be compared to $C_{i,meas}$ of mixed drilling fluid/groundwater samples as a function of flushing volume (and thus as a function of $X_{Li}[D]$), to verify how well the lithium spike method works as a proxy for drilling fluid contamination. In this manuscript, we refer to this method as a “four-point” method as four inputs are required (C_{Li} , $C_{Li}[D]$, $C_i[D]$ and $C_i[G]$).

3. Results and discussion

3.1. Drilling fluid contamination of casing water

Fig. 5 shows lithium concentration, as a marker for drilling fluid contamination, plotted as a function of number of well volumes flushed. Two sites of differing lithology (LR02 and LR06) were selected to compare the reduction of drilling fluid contamination as a function flushing volumes at locations of differing permeability, and well LR10 – 15 m was used as an example of flushing after direct water injection. Site LR02 (Fig. 5A and B) is more permeable and consists of a silty cap over sand increasing in grain size from fine to very coarse with depth, whereas site LR06 (Fig. 5C) has a 6 m silty/clay cap over fine/medium sand to 30 m depth. For both LR02–30 (Fig. 5A) and LR06–30 (Fig. 5C), there is a substantial decrease in lithium concentrations within the first two well volumes of flushing, followed by an asymptotic decrease towards the expected groundwater baseline (0.01 mg L^{-1}). The near baseline lithium concentrations in LR02 – 15 m (Fig. 5B) shows that there is no likely connectivity between the LR02 – 15 m (not spiked during drilling) and LR02 – 30 m (spiked during drilling) despite being located only two to three meters apart. This is expected given the 15 m vertical difference between the casing screens and the limited flushing

conducted.

Flushing which continued later after a time passage of >100 days (emphasized with grey circles in Fig. 5) indicated a further decrease in lithium concentrations due to dilution from the greater aquifer and natural groundwater movement. This confirms the “rule of thumb” adage that waiting for a period of time after drilling before groundwater sampling is advantageous and may substantially reduce drilling-related contamination. Lithium concentrations persist within discernible error above the baseline value for generally three to four well volumes of flushing. This is roughly consistent with previous work reporting that 16 to 21 well volumes of flushing were required for the organic tracer fluorescein to reduce to 0.05% of the original concentration (Wandrey et al., 2010), noting that organic dyes are more conservative tracers than inorganic tracers like lithium. This is particularly noteworthy for LR10 – 15 m (Fig. 5D) because lithium-spiked water was directly injected into the well due to operational issues encountered during flushing in order to displace settled sediment and debris. Even in this case, lithium concentrations decreased to baseline values within 4.5 well volumes of flushing.

The rates of diminution of lithium can be compared to mass balance calculations with an ideal mixing model (Fig. 5D) assuming perfect mixing between the lithium-spiked injection fluid and groundwater of baseline lithium concentration (0.01 mg L^{-1}). The shape of the observed curves for LR10 – 15 m is consistent with mass balance calculations. However, the actual rate of diminution is slower than predicted by ideal mixing models. This can be expected since the mixing that occurs within the casing is not complete mixing; any mixing results only from the entry of new water into the bottom one meter of the casing where there is screening and thus mixing will not be complete in practice, resulting in slower reduction of lithium concentrations than predicted by ideal mixing. Further, as discussed above, after waiting approximately 100 days, the observed concentrations after flushing are near baseline as predicted by ideal mixing models.

The typical method for reducing contamination induced by drilling is extensive well flushing (most industrial standard sampling procedures require three to 10 well volumes be removed prior to sampling (Ruda and Bosscher, 2005)), which does indeed reduce lithium concentrations as shown on Fig. 5. However, there is an inherent conflict between flushing volume and distance that water has travelled which can lead to difficulties in scientific interpretation due to uncertainties in the location from which the water has been derived. A suitable flushing volume needs to be determined by balancing three issues: (i) reducing drilling fluid contamination to a desired level (measured via tracer concentration); (ii) flushing a sufficient volume of water to remove debris, prevent clogging and to maintain usage of well (noting that if this has not been done sufficiently the well becomes inoperable); and (iii) minimizing the theoretical distance that water has travelled to enter the well. The optimal point here will depend on the ultimate objectives and hence vary on a case-to-case basis. For example, if the aim is to have a low degree of contamination, the water that has been derived may be from an unknown (or far) location; while if the aim is to know the origin of water samples, some degree of contamination is unavoidable. Alternatively, if the aim is supplying a water source for irrigation or domestic use, flushing volume needs to be determined by sufficient displacement of any settled debris in order to simply achieve successful well operation.

Fig. 6 shows this inherent trade-off between flushing volume (and hence reduction of drilling fluid contamination) and the theoretical distance from the radial center of the well screen from which water has been pulled in from an isotropic aquifer. This theoretical distance assumes idealized cylindrical transport for the height of the screen (one meter) and standard typical porosity

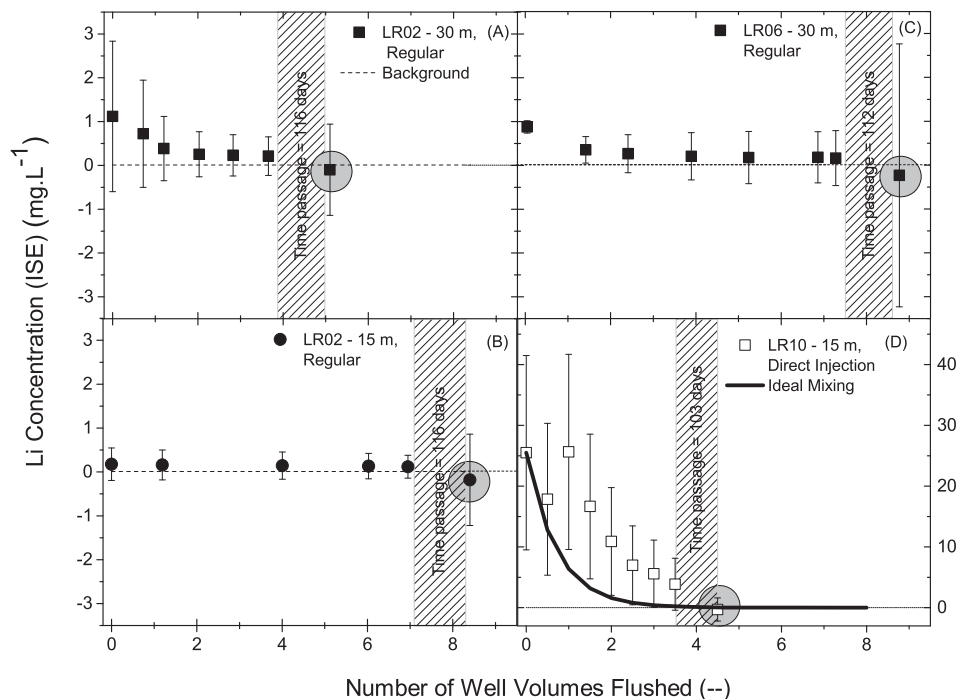

Fig. 5. Lithium (ISE) concentrations in casing water as a function of number of well volumes flushed in 15 m and 30 m wells for sites (A and B) LR02; (C) LR06-30 m; and (D) LR10-15 m where operational issues were encountered during flushing and lithium spiked water was directly injected into the well to remove settled debris during flushing. LR02 – 15 m, LR02 – 30 m and LR06 – 30 m were all flushed using regular methods. The mean baseline concentration of lithium in groundwater was 0.01 mg.L^{-1} . Lithium was spiked into the drilling fluid during drilling for (A) LR02-30 m and LR06-30 m only. Grey boxes indicate a substantial passage of time between flushing activities; data points to the left of the boxes were done within a few weeks of drilling and data points to the right were done approximately 100 days later. Grey circles highlight the lithium concentrations measured after the passage of time. Ideal mixing calculations assumed the concentration was consistent for the entire depth profile of the well at a given time. In reality a concentration gradient exists as “new” groundwater enters the casing only at the screening at the base of the well and there are no physical mixing mechanisms present within the casing. Note the scale for (D) is different than the others to show the higher concentrations initially encountered at LR10 – 15 m after direct lithium-spiked water injection.

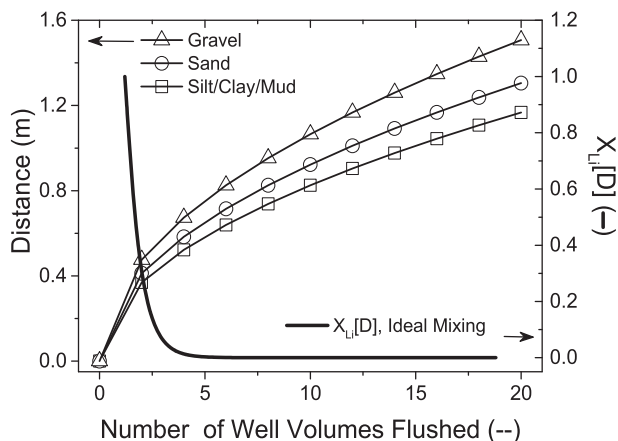

Fig. 6. Theoretical distance from the radial center of the well screen from which water is supplied plotted against number of well volumes flushed, assuming an absolute well volume of 107 L (as typical for a 30 m well with a 2 m water level), a cylindrical transport model, an idealized isotropic aquifer and default standard porosity values of 0.3, 0.4 and 0.5 for gravel, sand and sand/silt/mud, respectively (Domenico and Schwartz, 1998) (left-hand axis). The lithium based drilling fluid volume fraction $X_{Li}[D]$ is additionally plotted against number of well volumes flushed for an ideal mixing scenario (right-hand axis).

values of 0.3, 0.4 and 0.5 for gravel, sand and sand/silt/mud, respectively (Domenico and Schwartz, 1998; Ruda and Bosscher, 2005). As flushing increases, the distance from the screen from which the water originates increases, whereas $X_{Li}[D]$ decreases towards zero (e.g. background level). It is important to note that additional flushing does not linearly reduce drilling fluid

contamination but the origin of water is from continually farther distances, particularly if water is pulled quickly over a short time scale without time for the natural system to re-establish equilibrium. Fig. 6 is an idealized and simplified isotropic model, which does not reflect the heterogeneity encountered in real aquifer systems. This naturally occurring heterogeneity in real aquifer systems can have a major impact on the entry and removal of drilling fluid, groundwater and mixtures thereof.

$X_{Li}[D]$ can be calculated by two-point sampling if $C_{Li}[D]$ and C_{Li} are known (Table 1). Values for $X_{Li}[D]$ are given for wells of different sites, depths, lithology, flushing volume and flushing method (e.g. regular or direct water injection). In this table, $X_{Li}[D]$ has been calculated using both $C_{Li}(ISE)$ and $C_{Li}(ICP-AES)$. The high error associated with the ISE measurements (see Section 2.3) means that $X_{Li}[D](ISE)$ is only valid for cases of gross contamination (e.g. on the order of 100%). As can be seen on Table 3, $X_{Li}[D](ISE)$ is only greater than zero when errors are considered for extreme cases where (i) lithium-spiked water was directly injected into the well and (ii) wells were unable to be flushed (e.g. $WV < 0.5$) due to low water productivity usually resulting from heavily clay-dominated lithology. Instead, $X_{Li}[D](ICP-AES)$ provides a much better resolved approximation indicating contamination values ranging from 0.01 to 4.6%. In all cases $X_{Li}[D](ICP-AES)$ is greater than zero when errors are considered, unlike for $X_{Li}[D](ISE)$. It is significant to note that all $X_{Li}[D](ICP-AES)$ that are greater than 1% are in wells that were directly injected with lithium-spiked water, but that even in those scenarios all $X_{Li}[D](ICP-AES)$ were less than 5%. The values provided here on Table 1 could be used as broad approximations of the degree of contamination likely to occur from manual drilling techniques in incompletely consolidated shallow sediments as are

Table 1

Drilling fluid volume fraction, $X_{Li}[D]$ and associated number of well volumes (WV) flushed at various wells across 15 sites of different lithologies in Kandal Province, Cambodia. $X_{Li}[D](ISE) = C_{Li}(ISE)/C_{Li}[D](ISE)$ and $X_{Li}[D](ICP-AES) = C_{Li}(ICP-AES)/C_{Li}[D](ISE)$ as no drilling fluid samples were collected for ICP-AES analysis. *Indicates that $X_{Li}[D]$ is statistically greater than zero. Errors in ISE based on least squares regression modelling, ICP-AES errors were estimated at 5%, flushing volume errors are based on field estimates and $X_{Li}[D]$ errors on standard propagation. Samples were not collected for ICP-AES analysis where field measurements indicated very high contamination or where flushing/sampling was practically limited.

| Site | General lithology | Well ID | WV flushed | Flushing type | C_{Li} (ISE) (mg L ⁻¹) | C_{Li} (ICP-AES) (mg L ⁻¹) | $C_{Li}[D]$ (ISE) (mg L ⁻¹) | $X_{Li}[D]$ (ISE) (%) | $X_{Li}[D]$ (ICP-AES) (%) |
|-------------|---------------------------|---------|------------------|------------------|--------------------------------------|--|---|-----------------------|---------------------------|
| LR01 | Sandy, thin clay cap | LR01-6 | 4.0 ± 1.0 | Direct injection | -0.1 ± 0.5 | 0.603 ± 0.030 | 30 ± 5 | -0.4 ± 2 | 2.08 ± 0.3* |
| LR01 | Sandy, thin clay cap | LR01-9 | 6.0 ± 0.5 | Direct injection | -0.3 ± 4.1 | 0.304 ± 0.015 | 36 ± 6 | -0.9 ± 12 | 0.85 ± 0.1* |
| LR01 | Sandy, thin clay cap | LR01-21 | 6.0 ± 1.0 | Regular | -0.2 ± 0.9 | 0.006 ± 0.000 | 52 ± 34 | -0.3 ± 2 | 0.01 ± 0.0* |
| LR01 | Sandy, thin clay cap | LR01-45 | 5.2 ± 1.0 | Regular | 0.0 ± 0.1 | 0.143 ± 0.007 | 23 ± 17 | -0.1 ± 0 | 0.62 ± 0.5* |
| LR02 | Sandy, thin clay cap | LR02-30 | 5.1 ± 0.5 | Regular | -0.1 ± 0.7 | 0.007 ± 0.000 | 46 ± 45 | -0.3 ± 2 | 0.01 ± 0.0* |
| LR03 | Sandy, thin silt–clay cap | LR03-15 | 18.3 ± 0.5 | Regular | -0.3 ± 2.4 | 0.005 ± 0.000 | 31 ± 18 | -1.0 ± 8 | 0.01 ± 0.0* |
| LR04 | Sandy, thin silt–clay cap | LR04-30 | 4.5 ± 1.0 | Regular | -0.1 ± 0.4 | 0.003 ± 0.000 | 27 ± 22 | -0.3 ± 2 | 0.01 ± 0.0* |
| LR05 | Clay and sand | LR05-6 | 4.0 ± 1.0 | Direct injection | 0.3 ± 0.8 | 0.747 ± 0.037 | 40 ± 22 | 0.7 ± 2 | 1.88 ± 1.0* |
| LR05 | Clay and sand | LR05-9 | 4.0 ± 1.0 | Direct injection | -0.1 ± 0.5 | 0.168 ± 0.008 | 40 ± 22 | -0.3 ± 1 | 0.42 ± 0.2* |
| LR05 | Clay and sand | LR05-30 | 13.7 ± 0.5 | Regular | -0.1 ± 0.7 | 0.004 ± 0.000 | 55 ± 43 | -0.2 ± 1 | 0.01 ± 0.0* |
| LR06 | Sandy, silt–clay cap | LR06-30 | 6.3 ± 1.0 | Regular | 0.2 ± 0.6 | n/a | 36 ± 29 | 0.4 ± 2 | – |
| LR07 | Sandy, silt–clay cap | LR07-30 | 5.5 ± 0.5 | Regular | 0.1 ± 0.5 | 0.004 ± 0.000 | 29 ± 28 | 0.3 ± 1 | 0.01 ± 0.0* |
| LR08 | Silt–clay and sand | LR08-15 | 0.1 ± 0.1 | Direct injection | 65 ± 30.6 | n/a ± | 61 ± 29 | 106 ± 71* | – |
| LR08 | Silt–clay and sand | LR08-30 | 6.8 ± 0.5 | Regular | -0.3 ± 3.1 | 0.005 ± 0.000 | 25 ± 29 | -1.2 ± 13 | 0.02 ± 0.0* |
| LR09 | Silt–clay and sand | LR09-9 | 4.0 ± 1.0 | Direct injection | -0.2 ± 1.4 | 0.076 ± 0.004 | 42 ± 23 | -0.6 ± 3 | 0.18 ± 0.1* |
| LR09 | Silt–clay and sand | LR09-15 | 0.0 ± 0.1 | Direct injection | 50 ± 25.5 | n/a | 27 ± 17 | 188 ± 150* | – |
| LR09 | Silt–clay and sand | LR09-30 | 4.3 ± 1.0 | Regular | -0.1 ± 0.3 | 0.003 ± 0.000 | 25 ± 22 | -0.3 ± 1 | 0.01 ± 0.0* |
| LR09 | Silt–clay and sand | LR09-45 | 3.0 ± 1.0 | Direct injection | -0.2 ± 0.8 | 0.525 ± 0.026 | 18 ± 13 | -0.8 ± 4 | 2.90 ± 2.0* |
| LR10 | Sandy, thin clay–silt cap | LR10-9 | 3.0 ± 1.0 | Direct injection | 0.0 ± 0.2 | 0.032 ± 0.002 | 31 ± 18 | -0.2 ± 1 | 0.10 ± 0.1* |
| LR10 | Sandy, thin clay–silt cap | LR10-15 | 4.5 ± 1.0 | Direct injection | -0.3 ± 1.9 | 0.007 ± 0.000 | 25 ± 16 | -1.1 ± 8 | 0.03 ± 0.0* |
| LR10 | Sandy, thin clay–silt cap | LR10-21 | 3.7 ± 1.0 | Direct injection | -0.3 ± 1.6 | 0.087 ± 0.004 | 28 ± 17 | -0.9 ± 6 | 0.31 ± 0.2* |
| LR10 | Sandy, thin clay–silt cap | LR10-30 | 8.0 ± 1.0 | Direct injection | 0.2 ± 0.8 | 1.215 ± 0.061 | 28 ± 25 | 0.8 ± 3 | 4.3 ± 3.7* |
| LR11 | Clay | LR11-15 | 0.0 ± 0.1 | Direct injection | 52 ± 26 | n/a | 24 ± 15 | 218 ± 177* | – |
| LR11 | Clay | LR11-30 | 0.2 ± 0.1 | Direct injection | 48 ± 25 | n/a | 26 ± 16 | 182 ± 147* | – |
| LR12 | Sand, thick clay cap | LR12-15 | 0.2 ± 0.1 | Direct injection | 3.0 ± 3 | n/a | 18 ± 13 | 15 ± 21 | – |
| LR12 | Sand, thick clay cap | LR12-30 | 11.6 ± 0.5 | Regular | -0.3 ± 3 | 0.006 ± 0.000 | 31 ± 36 | -1.0 ± 9 | 0.02 ± 0.0* |
| LR13 | Clay | LR13-15 | 0.0 ± 0.1 | Direct injection | 17 ± 12 | n/a | 14 ± 11 | 123 ± 127* | – |
| LR13 | Clay | LR13-30 | 5.5 ± 0.5 | Regular | -0.1 ± 0.5 | 0.029 ± 0.001 | 31 ± 29 | -0.3 ± 2 | 0.09 ± 0.1* |
| LR14 | Clay | LR14-6 | 3.0 ± 1.0 | Direct injection | -0.3 ± 1.6 | 0.136 ± 0.007 | 63 ± 30 | -0.4 ± 3 | 0.22 ± 0.1* |
| LR14 | Clay | LR14-9 | 3.0 ± 1.0 | Direct injection | -0.1 ± 0.4 | 0.156 ± 0.008 | 70 ± 32 | -0.1 ± 1 | 0.22 ± 0.1* |
| LR14 | Clay | LR14-15 | 2.5 ± 0.5 | Direct injection | -0.1 ± 0.6 | 0.295 ± 0.015 | 70 ± 32 | -0.2 ± 1 | 0.42 ± 0.2* |
| LR14 | Clay | LR14-21 | 3.0 ± 1.0 | Direct injection | -0.1 ± 0.7 | 0.040 ± 0.002 | 60 ± 29 | -0.2 ± 1 | 0.07 ± 0.0* |
| LR14 | Clay | LR14-30 | 5.0 ± 1.0 | Regular | 1.0 ± 3 | 0.077 ± 0.004 | 69 ± 30 | 1.4 ± 4 | 0.11 ± 0.0* |
| LR15 | Sand | LR15-21 | 4.0 ± 1.0 | Regular | 0.3 ± 1 | 0.046 ± 0.002 | 121 ± 46 | 0.2 ± 1 | 0.04 ± 0.0* |
| Mean | – | – | 4.6 ± 3.8 | – | – | – | – | – | 0.6 ± 1.0 |

commonly encountered in Southeast Asia. If high accuracy estimates of $X_{Li}[D]$ are required for a particular system, it is recommended that specific measurements are made using ICP-AES for lithium analysis, and that samples for ICP-AES analysis are collected from the mixed drilling fluid-groundwater sample as well as the drilling fluid itself.

The data provided on Table 1 can be compared to general site lithology (Fig. 7). From here the general envelopes of expected $X_{Li}[D]$ values can be observed. In most cases, $X_{Li}[D]$ is <3% for three to seven well volumes flushed. Grey highlighting indicates where operational issues were encountered. Where flushing volumes were greater than 10, higher flushing volumes were required to ensure the future functionality of the well because of problems with excess fine sand and silt entering the screening during well development (note that each of these points is for a sand-dominated location). In the cases where the number of well volumes flushed was less than 0.5, the screening zones of the wells were in very low permeability, clay- or silt-clay-dominated stratigraphic layers where flushing and/or sampling is very difficult. Most points fell well within the range of $X_{Li}[D]$ < 3% for well flushing volumes of <7. Within the range where most points fall, there is no clear systematic difference according to lithology.

3.2. Strategies for the correction of monitoring well contamination

Measured groundwater parameters can be “corrected” for

drilling fluid contamination based directly on the concentration of remaining lithium tracer in the well, if the drilling fluid composition is also known. Table 2 shows the range of lithium-based levels of contamination or volume fraction of drilling fluid in the casing

Table 2

Example usage of lithium tracer data to correct for various water quality parameters in casing water for one model set of monitoring well data. The drilling fluid end-member was assumed to be a modern surface water of ¹⁴C-DOC age 50 ± 35 years and of composition 5 ± 0.3 mg L⁻¹ sodium and 80 ± 4 mg L⁻¹ dissolved organic carbon (DOC), and the model measured contaminated groundwater was assumed to be 500 ± 25 mg L⁻¹ sodium, 10 ± 0.5 mg L⁻¹ DOC and ¹⁴C-DOC age of 3000 ± 50 years. Grey highlighting indicates the magnitude of the corrections required for the typical range of drilling fluid contamination observed in incompletely consolidated sediments in Southeast Asia (see Table 1). Underlined data pairs indicate where the correction outliers the associated error.

| $X_{Li}[D]$ | Sodium (mg L ⁻¹) | | DOC (mg L ⁻¹) | | Model ¹⁴ C-DOC age (years BP) | |
|-------------|------------------------------|---------------|---------------------------|----------------|--|--------------|
| | $C_{Na,meas}$ | $C_{Na,corr}$ | $C_{DOC,meas}$ | $C_{DOC,corr}$ | $Age_{apparent}$ | Age_{real} |
| 10.0 ± 5% | 500 ± 25 | 555 ± 25 | 10 ± 0.5 | 2.2 ± 0.9 | 3000 ± 50 | 3404 ± 50 |
| 5.0 ± 4% | 500 ± 25 | 526 ± 25 | 10 ± 0.5 | 6.3 ± 1.0 | 3000 ± 50 | 3189 ± 50 |
| 3.0 ± 3% | 500 ± 25 | 515 ± 25 | 10 ± 0.5 | 7.8 ± 1.1 | 3000 ± 50 | 3110 ± 50 |
| 2.0 ± 2% | 500 ± 25 | 510 ± 25 | 10 ± 0.5 | 8.6 ± 1.1 | 3000 ± 50 | 3073 ± 50 |
| 1.5 ± 1% | 500 ± 25 | 508 ± 25 | 10 ± 0.5 | 8.9 ± 1.0 | 3000 ± 50 | 3054 ± 50 |
| 1.0 ± 1% | 500 ± 25 | 505 ± 25 | 10 ± 0.5 | 9.3 ± 1.1 | 3000 ± 50 | 3036 ± 50 |
| 0.5 ± 0.5% | 500 ± 25 | 503 ± 25 | 10 ± 0.5 | 9.6 ± 1.1 | 3000 ± 50 | 3018 ± 50 |
| 0.1 ± 0.1% | 500 ± 25 | 501 ± 25 | 10 ± 0.5 | 9.9 ± 1.1 | 3000 ± 50 | 3004 ± 50 |

Table 3

Example usage of lithium tracer based correction factors for the “two-point” volume fraction $X_{Li}[D]$ (ICP-AES) of drilling fluid in a groundwater/drilling fluid mixture to predict concentrations ($C_{i,pred}$) of other water constituents given approximated or known end member concentrations of a desired analyte in the drilling fluid $C_i[D]$ and the groundwater $C_i[G]$ for sites LR01–9 m (sand-dominated) and LR14 – 15 m (clay dominated), to compare to measured concentrations ($C_{i,meas}$) of mixed samples. The following assumptions were required: (1) $C_i[G]_{LR01-9m} \approx C_i[X_{Li}[D] = 0.9 \pm 0.1]$ for LR01 – 9 m; (2) $C_i[G]_{LR14-15m} \approx C_i[X_{Li}[D] = 0.4 \pm 0.2]$ for LR14 – 15 m; (3) $C_i[D]_{LR01-9m}$ prior to lithium spiking $\approx C_i[G]_{LR01-30m}$ as a nearby well approximately 30 m of depth was used as the drilling fluid; (4) $C_i[D]_{LR14-15m}$ prior to lithium spiking $\approx C_i[D]$ sampled three months subsequently. Both wells were flushed with direct injection of lithium-spiked water in February 2014. Estimated errors in predictions reflect these assumptions in addition to analytical errors; errors in $X_{Li}[D]$ are calculated using least squares regression modelling and errors in observed concentrations are approximately 5%. Grey highlighting indicates where the difference between predicted and observed concentrations outliers the propagated error.

| Type | WV | $X_{Li}[D]$ % | Sodium | | | Ammonium | | | Calcium | | | Alkalinity (HCO_3^-) | | |
|-------------|----|---------------|-----------------------|-----------------------|----------------|-----------------------|-----------------------|----------------|--------------------------|--------------------------|----------------|--------------------------|-----------------------|----------------|
| – | – | – | $C_{pred}(mg L^{-1})$ | $C_{meas}(mg L^{-1})$ | $\Delta C(\%)$ | $C_{pred}(mg L^{-1})$ | $C_{meas}(mg L^{-1})$ | $\Delta C(\%)$ | $C_{pred}(mg L^{-1})$ | $C_{meas}(mg L^{-1})$ | $\Delta C(\%)$ | $C_{pred}(mg L^{-1})$ | $C_{meas}(mg L^{-1})$ | $\Delta C(\%)$ |
| Sand (LR01) | 0 | 113 ± 19 | 21.0 ± 5.6 | 18.1 ± 0.9 | –16 ± 41 | 0.5 ± 1.1 | 1.9 ± 0.1 | 72 ± 76 | 41 ± 16 | 58.4 ± 2.9 | 29 ± 144 | 311 ± 130 | 307 ± 15 | –1.3 ± 26 |
| | 1 | 8.5 ± 1.4 | 13.0 ± 3.8 | 12.3 ± 0.6 | –5.3 ± 13 | 7.3 ± 2.9 | 7.5 ± 0.4 | 2 ± 9 | 73 ± 23 | 73.8 ± 3.7 | 1 ± 6.9 | 402 ± 154 | 427 ± 6 | 5.9 ± 128 |
| | 2 | 1.4 ± 0.1 | 12.4 ± 3.7 | 12.0 ± 0.6 | –3.4 ± 11 | 7.8 ± 3.0 | 7.7 ± 0.4 | –1 ± 8 | 75 ± 24 | 73.9 ± 3.7 | –2 ± 9.9 | 408 ± 156 | 434 ± 6 | 6.0 ± 132 |
| Type | WV | $X_{Li}[D]$ % | Chloride | | | Nitrate | | | Arsenic | | | Iron | | |
| – | – | – | $C_{pred}(mg L^{-1})$ | $C_{meas}(mg L^{-1})$ | $\Delta C(\%)$ | $C_{pred}(mg L^{-1})$ | $C_{meas}(mg L^{-1})$ | $\Delta C(\%)$ | $C_{pred}(\mu g L^{-1})$ | $C_{meas}(\mu g L^{-1})$ | $\Delta C(\%)$ | $C_{pred}(mg L^{-1})$ | $C_{meas}(mg L^{-1})$ | $\Delta C(\%)$ |
| Sand (LR01) | 0 | 113 ± 19 | 7.6 ± 2.1 | 232 ± 12 | 97 ± 1170 | 0.1 ± 0.2 | 0.5 ± 0.0 | 82 ± 33 | 534 ± 123 | 103 ± 5 | –419 ± 5126 | 8.6 ± 2.8 | 0.2 ± 0.0 | –4219 ± 7079 |
| | 1 | 8.5 ± 1.4 | 9.7 ± 2.6 | 25.2 ± 1.3 | 61 ± 82 | 0.9 ± 0.4 | 1.0 ± 0.1 | 7 ± 16 | 217 ± 56 | 189 ± 10 | –15 ± 145 | 9.9 ± 3.1 | 6.8 ± 0.3 | –46 ± 48 |
| | 2 | 1.4 ± 0.1 | 9.9 ± 2.6 | 11.0 ± 0.6 | 10 ± 17 | 1.0 ± 0.4 | 1.1 ± 0.1 | 10 ± 19 | 196 ± 51 | 201 ± 10 | 2 ± 25 | 10 ± 3.1 | 9.4 ± 0.5 | –6 ± 15 |
| Type | WV | $X_{Li}[D]$ % | Sodium | | | Ammonium | | | Calcium | | | Alkalinity (HCO_3^-) | | |
| – | – | – | $C_{pred}(mg L^{-1})$ | $C_{meas}(mg L^{-1})$ | $\Delta C(\%)$ | $C_{pred}(mg L^{-1})$ | $C_{meas}(mg L^{-1})$ | $\Delta C(\%)$ | $C_{pred}(mg L^{-1})$ | $C_{meas}(mg L^{-1})$ | $\Delta C(\%)$ | $C_{pred}(mg L^{-1})$ | $C_{meas}(mg L^{-1})$ | $\Delta C(\%)$ |
| Clay (LR14) | 0 | 8.1 ± 3.7 | 86.6 ± 48 | 85.1 ± 4.3 | –2 ± 15 | 32.5 ± 21 | 46.5 ± 2.3 | 30 ± 154 | 71.6 ± 41 | 83.5 ± 4.2 | 14 ± 109 | 619 ± 389 | 810 ± 41 | 24 ± 1060 |
| | 1 | 2.7 ± 1.2 | 89.6 ± 50 | 92.6 ± 4.6 | 3 ± 20 | 34.4 ± 22 | 31.8 ± 1.6 | –8 ± 27 | 74.2 ± 42 | 76.7 ± 3.8 | 3 ± 18 | 639 ± 399 | 700 ± 35 | 8.7 ± 304 |
| | 2 | 0.6 ± 0.3 | 90.7 ± 50 | 91.8 ± 4.6 | 1 ± 10 | 35.1 ± 22 | 24.8 ± 1.2 | –42 ± 0.80 | 75.2 ± 43 | 66.4 ± 3.3 | –13 ± 53 | 647 ± 403 | 639 ± 32 | –1.2 ± 40 |
| Type | WV | $X_{Li}[D]$ % | Chloride | | | Nitrate | | | Arsenic | | | Iron | | |
| – | – | – | $C_{pred}(mg L^{-1})$ | $C_{meas}(mg L^{-1})$ | $\Delta C(\%)$ | $C_{pred}(mg L^{-1})$ | $C_{meas}(mg L^{-1})$ | $\Delta C(\%)$ | $C_{pred}(\mu g L^{-1})$ | $C_{meas}(\mu g L^{-1})$ | $\Delta C(\%)$ | $C_{pred}(mg L^{-1})$ | $C_{meas}(mg L^{-1})$ | $\Delta C(\%)$ |
| Clay (LR14) | 0 | 8.1 ± 3.7 | 37.0 ± 20 | 69.4 ± 3.5 | 47 ± 264 | 0.8 ± 0.5 | 0.6 ± 0.0 | –29 ± 21 | 14.3 ± 8 | 21.3 ± 1.1 | 33 ± 98 | 0.5 ± 0.3 | 5.9 ± 0.3 | 92 ± 65 |
| | 1 | 2.7 ± 1.2 | 37.4 ± 20 | 48.9 ± 2.5 | 23 ± 65 | 0.8 ± 0.5 | 0.4 ± 0.2 | –120 ± 130 | 14.7 ± 8 | 16.3 ± 0.8 | 10 ± 23 | 0.5 ± 0.3 | 6.2 ± 0.3 | 92 ± 38 |
| | 2 | 0.6 ± 0.3 | 37.6 ± 20 | 41.1 ± 2.1 | 9 ± 27 | 0.8 ± 0.5 | 0.8 ± 0.4 | 4 ± 15 | 14.9 ± 8 | 9.3 ± 0.5 | –60 ± 76 | 0.5 ± 0.3 | 1.4 ± 0.1 | 64 ± 37 |

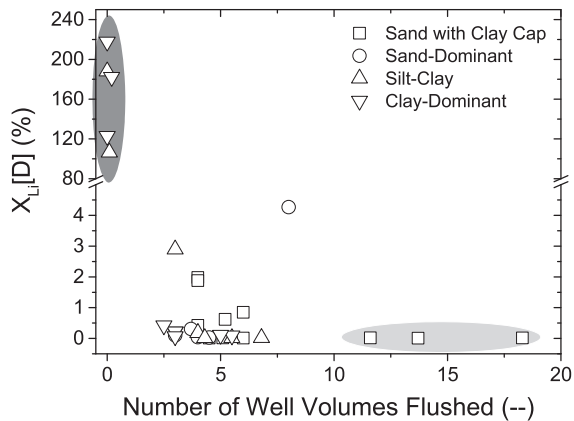

Fig. 7. Drilling fluid volume fraction $X_{Li}[D]$, as a function of number of well volumes (WV) flushed for different general lithologies. All $X_{Li}[D]$ are based on $X_{Li}[D]$ (ICP-AES) except the dark grey region. The dark grey shaded region indicates wells with very low permeability and $X_{Li}[D]$ are based here on (ISE) measurements due to high degrees of contamination. The light grey shaded region indicates where operational issues such as sand incursion were encountered which required exceptionally high WV flushed. Errors are not included for clarity but are shown on Table 1.

water, $X_{Li}[D]$, typically encountered (see Table 1) paired with model data to show (i) how $X_{Li}[D]$ can be used to correct a measured concentration $C_{i,meas}$ if $C_{i}[D]$ is known and (ii) how drilling fluid contamination can affect the interpretation of casing water chemistry. The parameters sodium, dissolved organic carbon (DOC) and ^{14}C -DOC age were selected due to general interest as well as broadly representing parameters that range from being not very sensitive to surface water contamination (sodium); somewhat sensitive to surface water contamination (DOC); and critically sensitive to surface water contamination (^{14}C -DOC age). The corrections shown on Table 2 indicate that corrections for parameters such as sodium and DOC are likely unnecessary when $X_{Li}[D]$ is < 2 – 3% , as was typically encountered in this study (see Table 1), as the errors introduced by correction fall within the typical analytical and sampling errors for these parameters. However, it is important to note that in the particular circumstance where drilling fluid may have much higher DOC than groundwaters, or vice versa with drilling fluid having much lower DOC than groundwaters in organic-rich alluvial sediments, corrections may still be necessary and significant. Similarly, sensitive parameters such as ^{14}C -DOC model age are more susceptible to the influence of drilling fluid contamination even at lower levels of $X_{Li}[D]$.

As ^{14}C -DOC model age is expected to be highly sensitive to surface water contamination and because of the specific interest of this parameter to current debates regarding the ingress of surface-derived waters on arsenic release in groundwaters (Aggarwal et al., 2003; Harvey et al., 2002; Polya and Charlet, 2009), additional modelling was conducted to determine the effect of drilling fluid contamination on groundwaters of differing ^{14}C -DOC model ages for the range of drilling fluid contamination typically encountered (Fig. 8). Drilling fluid contamination has minimal effect on apparent ^{14}C -DOC model age when the drilling fluid and groundwater are of similar real age. But in the case where drilling fluid is very young (e.g. 50 years, as in Fig. 8A), for example, even very low levels of contamination can have drastic influence on the apparent ^{14}C -DOC age for older groundwaters. For older groundwaters (e.g. 30,000 years), drilling fluid contamination from a modern drilling fluid of model age 50 years can result in the apparent age underestimating the real age by greater than 4500 years for $X_{Li}[D] = 2\%$, or around 9000 years for $X_{Li}[D] = 5\%$. Conversely, if a relatively old groundwater (e.g. 15,000 years, as in Fig. 8C) is used for drilling fluid, the apparent age will be an overestimate of the real age by around 200

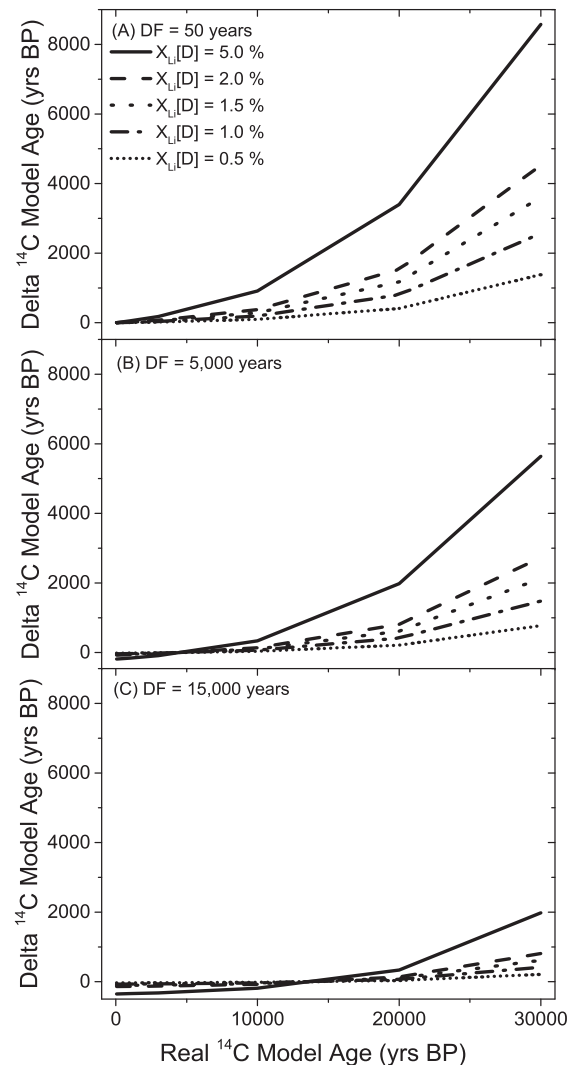

Fig. 8. Delta ^{14}C -DOC groundwater model age (real age minus apparent age) versus groundwater real age for the ranges of volume fraction drilling fluid contamination, $X_{Li}[D]$ typically encountered for aquifers hosting poorly consolidated sediments for a drilling fluid (DF) real ^{14}C -DOC age of (A) 50 years BP; (B) 5,000 years BP; and (C) 15,000 years BP.

years for an otherwise modern water (e.g. 50 years) with $X_{Li}[D] = 5\%$, or an overestimate by around 5600 years for a groundwater that is 30,000 years old with $X_{Li}[D] = 5\%$. Understandably, the maximum effect is observed when there is the largest difference in real ages between the groundwater and drilling fluid, with the highest degrees of drilling fluid contamination. In these cases, correction for drilling fluid contamination is essential and negligence can result in underestimates in ^{14}C -DOC model age on the order of thousands of years. A similar impact of drilling fluid contamination could also be expected for other age related parameters, such as apparent tritium determinations, where the largest influence would occur with the highest degree of modern drilling fluid contributions to an otherwise tritium-dead groundwater. Similar mixing considerations can be made during chloro-fluorocarbon (CFC) or sulfur hexafluoride (SF_6) interpretations (Darling et al., 2012).

3.3. Lithium tracer verification

The verification of the use of lithium tracers as drilling-based

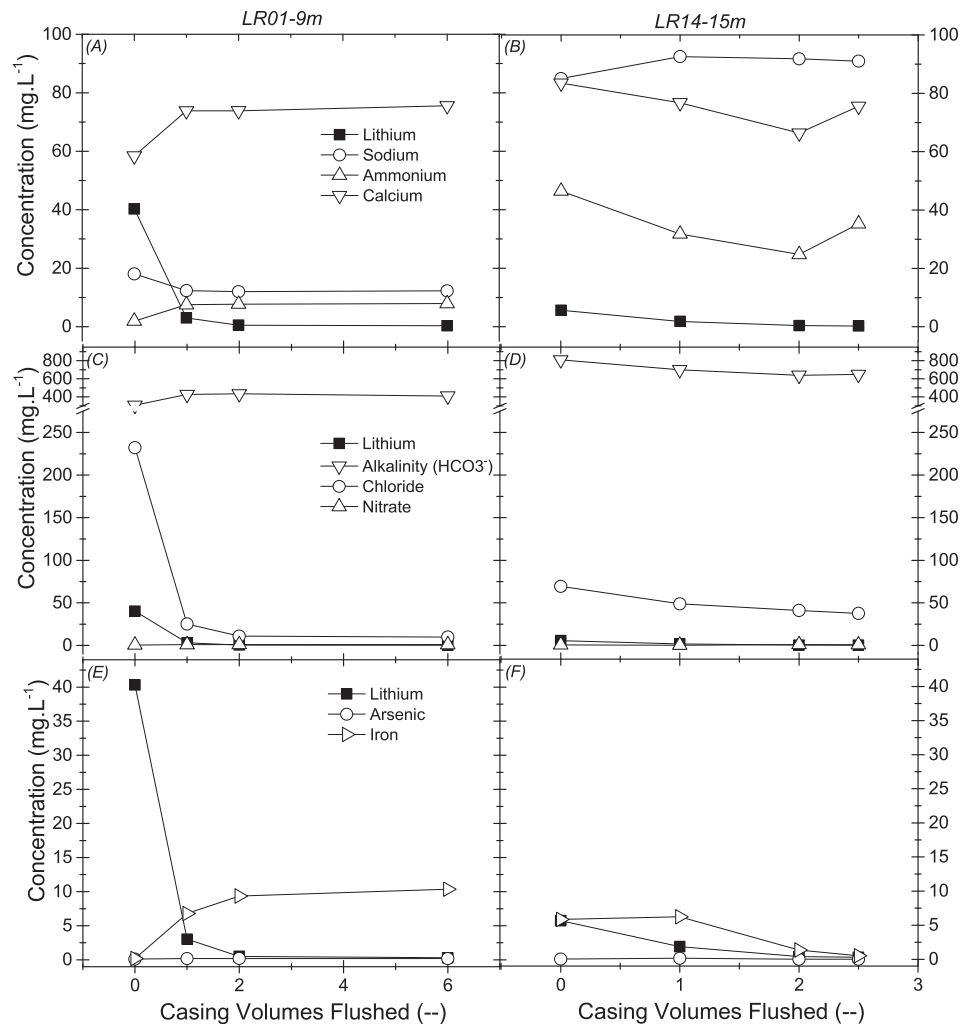

Fig. 9. Concentrations of spiked lithium with naturally occurring groundwater major cations (**A and B**), major anions (**C and D**) and trace elements (**E and F**). Site LR01-9 m is a shallow (9 m) well of relatively high hydraulic conductivity with which spiked groundwater was used to directly inject the well during flushing (**A, C, E**); site LR14-15 m is a mid-depth (15 m) well in a clay dominated area with low hydraulic conductivity with which spiked surface water was used to directly inject the well during flushing to displace settled mud/debris (**A, D, F**). Analytical errors are not shown for clarity but are estimated to be 3% for chloride and arsenic; 5% for lithium and sodium; 6% for iron and calcium; and 10% for ammonium, alkalinity and nitrate.

contamination proxies was tested by comparing the changing concentrations of spiked lithium with a selected suite of natural water constituents, namely sodium, ammonium, calcium, alkalinity as HCO_3^- , chloride, nitrate, arsenic and iron, with a contrasting range of physical and chemical behaviors. Two sites of very different lithologies (LR14 and LR01) were selected for method verification. Site LR14 is heavily clay-dominated, has low hydraulic conductivity and was drilled using surface water as the drilling fluid, whereas LR01 has relatively high hydraulic conductivity and was drilled using groundwater as the drilling fluid. The two sites have distinctly different water composition of the groundwaters themselves as well as the drilling fluid used.

Fig. 9 shows the concentration of natural water constituents as a function of flushing volume at site LR01 (Fig. 9A, C, E) and at site LR14 (Fig. 9B, D, F). Here, in each of the scenarios, as lithium concentration diminishes with flushing volume, trends are also observed in the concentrations of other water constituents. For example, at site LR01 (Fig. 9A, C, E), as lithium concentration diminishes, calcium, alkalinity and iron all clearly increase; whereas both sodium and chloride diminish correspondingly. This suggests that the drilling fluid has relatively high concentrations of lithium, sodium, and chloride and relatively low concentrations of calcium,

alkalinity and iron as compared to the casing water. These differences in values can be used to deduce the end-member concentrations of both the drilling fluid itself and the casing water being sampled.

Site LR14 is very different when compared to site LR01, as it is heavily clay-dominated, has low hydraulic conductivity and has distinctly different water composition, and was drilled/flushed using surface water as the drilling fluid rather than groundwater. Trends in the concentrations of a suite of natural constituents with lithium concentration can also be observed here (Fig. 9B, D, F). Here, the largest changes in concentration were observed with calcium, ammonium, alkalinity, chloride and iron, all of which decrease with increased flushing. These are different trends than were observed with LR01, which can be attributed to the natural differences in water quality and the differences in the composition of the drilling fluid used (e.g. surface water at LR14 rather than groundwater at LR01). The trends in general at site LR14 were less drastic than with LR01 which is consistent with the low hydraulic conductivity of the well. Because site LR14 has very low hydraulic conductivity and is of low productivity, the maximum flushing volume practically achievable was 2.5 well volumes. This flushing was achieved over a period of several weeks at the start of the rainy season in Cambodia

and it cannot be assumed that the groundwater composition was necessarily constant during this period.

As previously observed on Fig. 5, the most significant changes for all of the natural constituents for both sites occur within the first two well volumes. As the lithium concentration becomes stable, so do the concentrations of each of the other major and trace constituents within the same volume of flushing. This is observed for two different sites of very different hydrological and geochemical characteristics. This provides evidence that the lithium spike is qualitatively a robust, reliable and representative tracer of various constituents in natural waters. The utility of the lithium tracer method was further explored by using the measured $X_{Li}[D]$ as a function of flushing volume at LR01 and LR14 to predict the concentrations of different constituents in the groundwater and compare with observed concentrations, giving assumptions for $C_i[D]$ and $C_i[G]$ at both sites (Table 3).

Predicted concentrations for drilling fluid – groundwater mixtures as a function of $X_{Li}[D]$ are shown in Table 3 for sodium, ammonium, calcium, alkalinity, chloride, nitrate, arsenic and iron. In most cases (43 of 48 scenarios), the differences in $C_{i,pred}$ and $C_{i,obs}$ for a given analyte are not significant when errors in $X_{Li}[D]$, $C_i[D]$ and $C_i[G]$ are considered (grey highlighting indicates where differences outlie the propagated error). The general broad agreement within error of predicted and observed concentrations despite differences in lithology, type of analyte and $X_{Li}[D]$ does provide verification of lithium tracers as a proxy for drilling based contamination. However, if high accuracy predictions are required, it is recommended that all samples from both $C_i[D]$ and $C_i[G]$ at the time of flushing are collected and analyzed in order to reduce the errors associated with the predictions.

4. Conclusions

Lithium chloride tracers have been used to quantitatively evaluate and correct for drilling fluid contamination of casing waters through an investigation of 34 monitoring wells at 15 sites in Kandal Province, Cambodia. A field technique using an ion selective electrode for lithium measurements can provide estimates of gross contamination which can be used to optimize sample collection. For specific, higher resolution corrections for contamination to be made, laboratory measurements of lithium using ICP-AES (of both groundwater and drilling fluid samples) are recommended for higher accuracy and lower detection at concentrations near baseline, even though this obviously creates limitations for field practicality. Lithium concentrations in casing water arising from drilling fluid contamination are significantly reduced with two to three well volumes of flushing but nevertheless can still persist above background values for at least seven well volumes of flushing. A waiting period of the order of 100 days after drilling allows for contamination levels to decrease further towards baseline due to natural dilution with the surrounding aquifer, particularly for permeable sites. The mean drilling fluid contamination value was $0.6 \pm 1\%$ for all 27 monitoring wells analyzed with ICP-AES, with 26 of those 27 wells $<3\%$ and a maximum of $4.3 \pm 3.7\%$ after a mean flushing volume of 4.6 ± 3.8 well volumes (even for wells which were directly injected with lithium spiked water during flushing to remove settled mud/debris). Contamination was considered with regard to dominant lithology as well as operational issues, with decreased flushing noted at low permeability and clay-dominated wells. The typical ranges of $X_{Li}[D]$ encountered were used to demonstrate how to make Li-based corrections for other groundwater parameters. This can be very important for parameters such as ^{14}C model age, where a contamination of even 1% can lead to a mis-estimation of ^{14}C age on the order of hundreds to thousands of years if the differences in ages between the groundwater and

drilling fluid are large. If flushing volumes and/or waiting periods prior to sampling are sufficiently high then corrections may not be necessary, however these practicalities cannot always be ensured in field situations. The lithium tracer method was verified by evaluating the changes in concentration of a number of other natural groundwater constituents as a function of flushing volume. It was demonstrated that the lithium spike is broadly representative tracer of various constituents in natural waters as predictions and observed concentrations were generally within modelled errors. This study provides valuable information on the degree of unavoidable contamination introduced by manual drilling techniques and suggests potential methods of compensation and/or correction.

Acknowledgments

This research was funded by a NERC Standard Research Grant (NE/J023833/1) to DP, BvD and CB and an NERC PhD studentship (NE/L501591/1) to DM. We are deeply indebted to the essential help of Chansopheaktra Sovann (Royal University of Phnom Penh) and Chivuth Kong (Royal University of Agriculture, Phnom Penh), the hard work and expertise of our local drilling team led by Hok Meas (Kandal Province, Cambodia) and the permissions, support and interest of local landowners and tenants. Pheary Meas and Yut Yann (Royal University of Agriculture, Phnom Penh) and Dina Kuy (Resources Development International – Cambodia) also provided field support for which we are extremely grateful. The usage of the laboratory facilities at Resources Development International – Cambodia was essential to the completion of this work. We greatly appreciate the coordination assistance and support of Lori Frees (Resources Development International – Cambodia) and Lori Allen (University of Wisconsin – Parkside). Paul Lythgoe (The University of Manchester) is gratefully thanked for ICP analysis, and Alastair Bewsher (The University of Manchester) for IC analysis. Graham Craik (Simulation Solutions) is thanked for proofreading. We also thank the two anonymous reviewers and associate editor for their comments on this manuscript.

References

- Adams, M.C., Moore, J.N., Fabry, L.G., Ahn, J.-H., 1992. Thermal stabilities of aromatic acids as geothermal tracers. *Geothermics* 21, 323–339.
- Aggarwal, P.K., Basu, A.R., Kulkarni, K.M., 2003. Comment on “Arsenic mobility and groundwater extraction in Bangladesh” (I). *Science* 300, 584b.
- Bath, A., 2011. Drilling Fluid Tracers – Review and Update of Industry Experience and Issues for RWMD Site Characterisation Programme. Intellisci Ltd., Nuclear Decommissioning Authority Radioactive Waste Management Directorate (accessed 15.04.15.). <http://www.nda.gov.uk/publication/drilling-fluid-tracers-review-and-update-of-industry-experience-and-issues-for-rwmd-site-characterisation-programme-april-2011/>.
- Benner, S.G., Polizzotto, M.L., Kocar, B.D., Ganguly, S., Phan, K., Ouch, K., Sampson, M., Fendorf, S., 2008. Groundwater flow in an arsenic-contaminated aquifer, Mekong Delta, Cambodia. *Appl. Geochem.* 23, 3072–3087.
- Bottrell, S.H., Thornton, S.F., Spence, M.J., Allshorn, S., Spence, K.H., 2010. Assessment of the use of fluorescent tracers in a contaminated Chalk aquifer. *Q. J. Eng. Geol. Hydrogeol.* 43, 195–206.
- Buschmann, J., Berg, M., 2009. Impact of sulfate reduction on the scale of arsenic contamination in groundwater of the Mekong, Bengal and Red River deltas. *Appl. Geochem.* 24, 1278–1286.
- Carroll, D., 1959. Ion exchange in clays and other minerals. *Geol. Soc. Am. Bull.* 70, 749–779.
- Chan, L.-H., Kastner, M., 2000. Lithium isotopic compositions of pore fluids and sediments in the Costa Rica subduction zone: implications for fluid processes and sediment contribution to the arc volcanos. *Earth Planet. Sci. Lett.* 183, 275–290.
- Charlet, L., Polya, D.A., 2006. Arsenic in shallow, reducing groundwaters in southern Asia: an environmental health disaster. *Elements* 2, 91–96.
- Chrysikopoulos, C.V., Kruger, P., 1987. Investigation of soluble indium chelates for groundwater and hydrothermal fluid tracing. *Appl. Geochem.* 2, 329–335.
- Darling, W.G., Gooddy, D.C., MacDonald, A.M., Morris, B.L., 2012. The practicalities of using CFCs and SF₆ for groundwater dating and tracing. *Appl. Geochem.* 27, 1688–1697.

- Di Fazio, A., Vurro, M., 1994. Experimental tests using rhodamine WT as tracer. *Adv. Water Resour.* 17, 375–378.
- Dierberg, F.E., DeBusk, T.A., 2005. An evaluation of two tracers in surface-flow wetlands: rhodamine-WT and lithium. *Wetlands* 25, 8–25.
- Domenico, P.A., Schwartz, F.W., 1998. *Physical and Chemical Hydrogeology*, second ed. John Wiley & Sons, Inc.
- Edmunds, W.M., Bath, A.H., 1976. Centrifuge extraction and chemical analysis of interstitial waters. *Environ. Sci. Technol.* 5, 467–472.
- Gast, R.G., Klobe, W.D., 1971. Sodium-lithium exchange equilibria on vermiculite at 25° and 50° C. *Clays Clay Miner.* 19.
- Goody, D.C., Darling, W.G., Abesser, C., Lapworth, D.J., 2006. Using chlorofluorocarbons (CFCs) and sulphur hexafluoride (SF₆) to characterise groundwater movement and residence time in a lowland Chalk catchment. *J. Hydrol.* 330, 44–52.
- Harvey, C.F., Swartz, C.H., Badruzzaman, A.B.M., Keon-Blute, N., Ali, M.A., Jay, J., Beckie, R., Oates, P.M., Ashfaq, K.N., Islam, S., Hemond, H.F., Ahmed, M.F., 2003. Response to comments on “Arsenic mobility and groundwater extraction in Bangladesh”. *Science* 300, 584d.
- Harvey, C.F., Swartz, C.H., Badruzzaman, A.B.M., Keon-Blute, N., Yu, W., Ashraf Ali, M., Jay, J., Beckie, R., Niedan, V., Brabander, D., Oates, P.M., Ashfaq, K.N., Islam, S., Hemond, H.F., Ahmed, M.F., 2002. Arsenic mobility and groundwater extraction in Bangladesh. *Science* 298, 1602–1606.
- Kallmeyer, J., Mangelsdorf, K., Cragg, B., Horsfield, B., 2006. Techniques for contamination assessment during drilling for terrestrial subsurface sediments. *Geomicrobiol. J.* 23, 227–239.
- Kinniburgh, D.G., Smedley, P.L., 2001. Arsenic Contamination of Groundwater in Bangladesh, Vol. 2: Final Report. BGS Technical Report WC/00/19. In: *British Geological Survey*, vol. 2.
- Kleven, R., Dahl, J.B., Bjørnstad, T., Qvenild, C., Tollan, O., 1996. Use of tracers for mud filtrate and completion fluid invasion studies. *J. Pet. Sci. Eng.* 16, 15–32.
- Lawson, M., Polya, D.A., Boyce, A.J., Bryant, C., Mondal, D., Shantz, A., Ballentine, C.J., 2013. Pond-derived organic carbon driving changes in arsenic hazard found in Asian groundwaters. *Environ. Sci. Technol.* 47, 7085–7094.
- Lloyd, J.R., Oremland, R.S., 2006. Microbial transformations of arsenic in the environment: from soda lakes to aquifers. *Elements* 2, 85–90.
- McArthur, J.M., Ravenscroft, P., Sracek, O., 2011. Aquifer arsenic source. *Nat. Geosci.* 4, 655–656.
- McCartney, R.A., de L.G. Solbé, M., 1999. Use of Tracers in Drilling Muds to Allow the Estimation of in-situ Formation Water Compositions from Drilling-mud-contaminated Formation Water Samples. Society of Petroleum Engineers SPE 50721.
- McKinley, J.P., Colwell, F.S., 1996. Application of perfluorocarbon tracers to microbial sampling in subsurface environments using mud-rotary and air-rotary drilling techniques. *J. Microbiol. Methods* 26, 1–9.
- Miller, J.N., Miller, J.C., 2010. Chapter 5: Calibration Methods in Instrumental Analysis: Regression and Correlation, Statistics and Chemometrics for Analytical Chemistry. Pearson Education.
- Neumann, R.B., Ashfaq, K.N., Badruzzaman, A.B.M., Ali, M.A., Shoemaker, J.K., Harvey, C.F., 2010. Anthropogenic influences on groundwater arsenic concentrations in Bangladesh. *Nat. Geosci.* 3, 46–52.
- Penteleit, B., Kessels, W., Binot, F., 2006. Mud tracer test during soft rock drilling. *Water Resour. Res.* 42.
- Polizzotto, M.L., Kocar, B.D., Benner, S.G., Sampson, M., Fendorf, S., 2008. Near-surface wetland sediments as a source of arsenic release to ground water in Asia. *Nature* 454, 505–508.
- Polya, D.A., Berg, M., Gault, A.G., Takahashi, Y., 2008. Arsenic in groundwaters of south-east Asia: with emphasis on Cambodia and Vietnam. *Appl. Geochem.* 23, 2968–2976.
- Polya, D.A., Charlet, L., 2009. Rising arsenic risk? *Nat. Geosci.* 2, 383–384.
- Ptak, T., Piepenbrink, M., Martac, E., 2004. Tracer tests for the investigation of heterogeneous porous media and stochastic modelling of flow and transport – a review of some recent developments. *J. Hydrol.* 294, 122–163.
- Riley, M.S., Ward, R.S., Greswall, R.B., 2001. Converging flow tracer tests in fissured limestone. *Q. J. Eng. Geol. Hydrogeol.* 34, 283–297.
- Rowland, H.A.L., Gault, A.G., Lythgoe, P., Polya, D.A., 2008. Geochemistry of aquifer sediments and arsenic-rich groundwaters from Kandal Province, Cambodia. *Appl. Geochem.* 23, 3029–3046.
- Rowland, H.A.L., Pederick, R.L., Polya, D.A., Pancost, R.D., Van Dongen, B.E., Gault, A.G., Vaughan, D.J., Bryant, C., Anderson, B., Lloyd, J.R., 2007. The control of organic matter on microbially mediated iron reduction and arsenic release in shallow alluvial aquifers, Cambodia. *Geobiology* 5, 281–292.
- Ruda, T.C., Bosscher, P.J., 2005. *National Drilling Association Driller's Manual*. <http://www.nda4u.com/trainingcenter/downloads/drillersmanual.pdf> (accessed 13.07.15).
- Sabiani, D.A., Austin, T.A., 1991. Characteristics of rhodamine WT and fluorescein as adsorbing groundwater tracers. *Groundwater* 29, 341–349.
- Sengupta, S., McArthur, J., Sarkar, A., Leng, M.J., Ravenscroft, P., Howarth, R.J., Banerjee, D.M., 2008. Do ponds cause arsenic-pollution of groundwater in the Bengal Basin? An answer from West Bengal. *Environ. Sci. Technol.* 42, 5156–5164.
- Shand, P., Edmunds, W.M., Lawrence, A.R., Smedley, P.L., Burke, S., 2007. The Natural (Baseline) Quality of Groundwater in England and Wales. In: *British Geological Survey*, p. 53 (Research Report RR/07/06) and Environment Agency (Technical Report NC/99/74/24).
- Smart, P.L., Laidlaw, I.M.S., 1977. An evaluation of some fluorescent dyes for water tracing. *Water Resour. Res.* 13, 15–33.
- Smith, D.C., Spivack, A.J., Fisk, M.R., Haveman, S.A., Staudiegel, H., 2000. Tracer-based estimates of drilling-induced microbial contamination of deep sea crust. *Geomicrobiol. J.* 17, 207–219.
- Sovann, C., Polya, D.A., 2014. Improved groundwater geogenic arsenic hazard map for Cambodia. *Environ. Chem.* 11, 595–607.
- Tamura, T., Saito, Y., Sieng, S., Ben, B., Kong, M., Chou, S., Tsukawaki, S., 2007. Depositional facies and radiocarbon ages of a drill core from the Mekong River lowland near Phnom Penh, Cambodia: evidence for tidal sedimentation at the time of Holocene maximum flooding. *J. Asian Earth Sci.* 29, 585–592.
- United States Environmental Protection Agency Environmental Response Team, 2001. Standard Operating Procedures (SOP 2044): Monitor Well Development. <http://www.dem.ri.gov/pubs/sops/wmsr2044.pdf> (accessed 15.07.15).
- van Dongen, B., Rowland, H.A.L., Gault, A.G., Polya, D.A., Bryant, C., Pancost, R.D., 2008. Hopane, sterane and n-alkane distributions in shallow sediments hosting high arsenic groundwaters in Cambodia. *Appl. Geochem.* 23, 3047–3058.
- van Geen, A., Protus, T., Cheng, Z., Horneman, A., Seddique, A.A., Hoque, M.A., Ahmed, K.M., 2004. Testing groundwater for arsenic in Bangladesh before installing a well. *Environ. Sci. Technol.* 38, 6783–6789.
- van Geen, A., Zheng, Y., Goodbred, S., Horneman, A., Aziz, Z., Cheng, Z., Stute, M., Mailloux, B., Weinman, B., Hoque, M.A., Seddique, A.A., Hossain, M.S., Chowdhury, S.H., Ahmed, K.M., 2008. Flushing history as a hydrogeological control on the regional distribution of arsenic in shallow groundwater of the Bengal Basin. *Environ. Sci. Technol.* 42, 2283–2288.
- van Geen, A., Zheng, Y., Stute, M., Ahmed, K.M., 2003. Comment on “Arsenic mobility and groundwater extraction in Bangladesh” (II). *Science* 300, 584c.
- Vereecken, H., Döring, U., Hardelauf, H., Jaekel, U., Hashagen, U., Neuendorf, O., Schwarze, H., Seidemann, R., 2000. Analysis of solute transport in a heterogeneous aquifer: the Krauthausen field experiment. *J. Contam. Hydrol.* 45, 329–358.
- Wandrey, M., Morozova, D., Zettlitzer, M., Würdemann, H., Group, C.S., 2010. Assessing drilling mud and technical fluid contamination in rock core and brine samples intended for microbiological monitoring at the CO₂ storage site in Ketzin using fluorescent dye tracers. *Int. J. Greenh. Gas Control* 4, 972–980.
- Warner, N.R., Darrah, T.H., Jackson, R.B., Millot, R., Kloppmann, W., Vengosh, A., 2014. New tracers identify hydraulic fracturing fluids and accidental release from oil and gas operations. *Environ. Sci. Technol.* <http://dx.doi.org/10.1021/es5032135>.
- You, C.-F., Chan, L.-H., Spivack, A.J., Gieskes, J.M., 1995. Lithium, boron, and their isotopes in sediments and pore waters of ocean drilling program site 808, Nankai Trough: implications for fluid expulsion in accretionary prisms. *Geology* 23, 37–40.
- Zhang, L., Chan, L.-H., Gieskes, J.M., 1998. Lithium isotope geochemistry of pore waters from ocean drilling program sites 918 and 919, Irminger Basin. *Geochim. Cosmochim. Acta* 62, 2437–2450.